

Central Controller Operation & Installation Manual

YCZ-A004

CONTENT

Function introduction of central controller.....	1
Part info for central controller	2
Page & Key Explanation.....	4
Address Setting When Using Central Controller	6
Function Operation	9
Installation	28

- Please read this manual carefully before using.
- Keep this operation manual for future reference.

Function introduction of central controller

1. YCZ-A004 can control MRV series units. 256 indoor units can be controlled when used with MRV.

The YCZ-A004 should be used together with an IGU05. One IGU05 adapter is connected with one outdoor MRV system. If multiple outdoor MRV units are to be connected to one YCZ-A004 central controller then an IGU05 adapter is needed for each outdoor MRV unit.

2. Main functions of central controller

- ① Monitoring and controlling indoor running state such as ON/OFF, Mode, Fan, Set temp. and error code.
- ② Zone setting, editing and deleting.
- ③ Realizing ON/OFF, mode, fan, temperature setting for single/zone/all indoor unit(s).
- ④ Checking indoor unit detailed information such as real temperature, coil temperature, error code.
- ⑤ For MRV, three kinds of controlling mode: LIFO (Last In First Out), Central & Force can be selected for indoor units; while only Force & LIFO mode can be selected for single split unit.
LIFO: The indoor unit will execute the last order sent by any controller. For example, if the fan speed is set to low by the central controller and then later the fan is set to high speed by another controller, the indoor unit will set its fan to high.
Central: The central controller controls all functions while wired & remote controllers can only control ON/OFF of indoor units.
Force: The central controller controls all functions while wired & remote controller cannot control indoor units. They will display current settings.
- ⑥ Fire Alarm Shutdown: If the building fire alarm system is connected to the controller and an alarm signal is sent, the central controller will turn all indoor units off.
- ⑦ Multiple timer settings. Users can set the system to turn on/off, run in any mode and at any temp. Timer can be set for single indoor units or zones.

Part info for central controller

ON/OFF key:

Press the ON/OFF key for 2-3 seconds to turn on the controller after powering on. To turn off, press the ON/OFF key for 5 seconds.

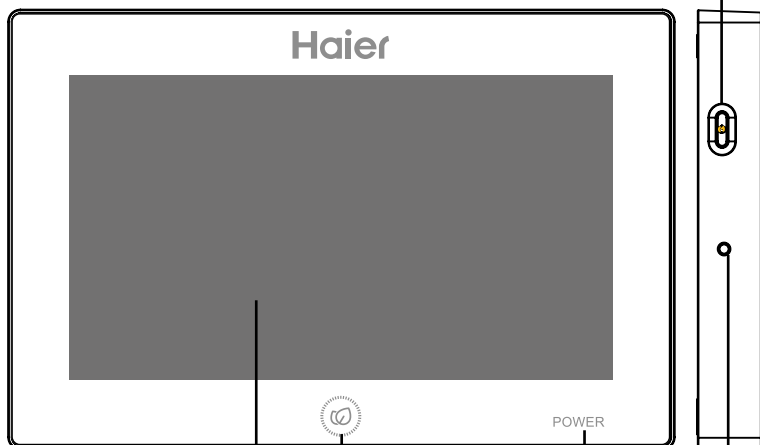

Display/touch screen:

Display and operation area.

Screensaver key:

Press to turn off screen light and press again to turn on.

Power light:

Power light will be on after powering on.

Reset key:

Press to reboot central controller.

Part info for central controller

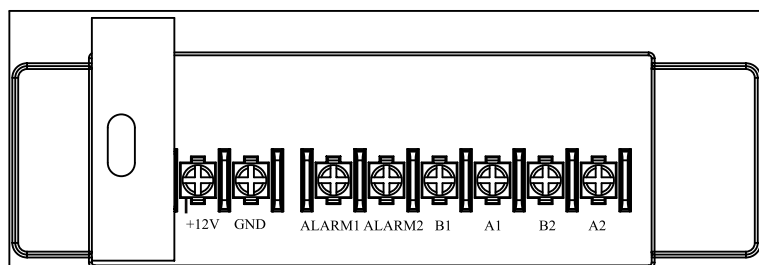
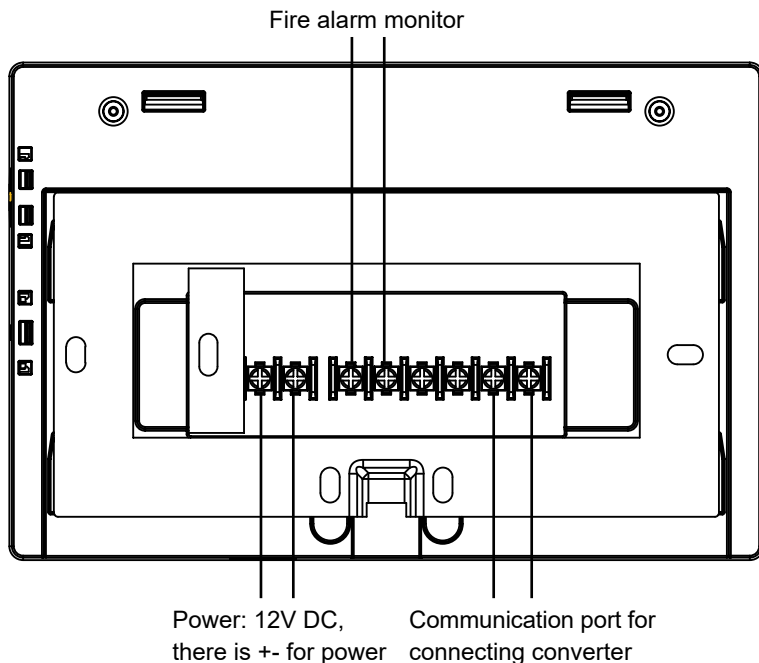





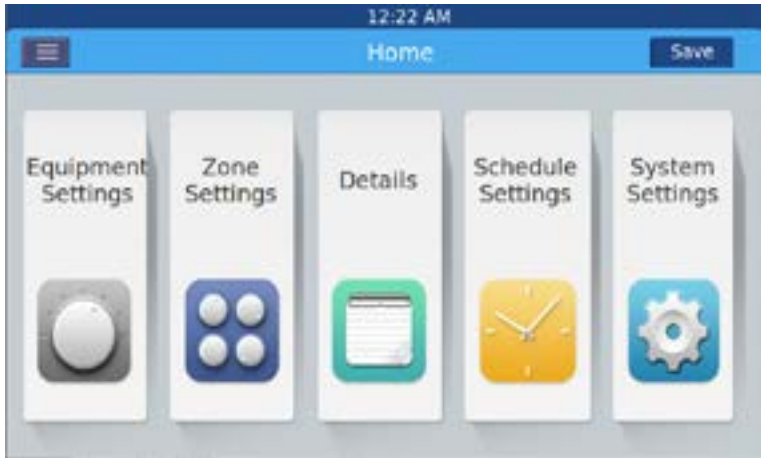

Power (12V, GND): 12V DC, please pay attention to +-of power.
Fire alarm linkage contact (ALARM1, ALARM2): AC works normally when closed and all AC turned off when open circuit.
Third party interface (B1, A1): A1 should be connected to 485+ while B1 485-.
Communication port (B2, A2): It is used for connecting converter, please pay attention to +-. A2 should be connected to 485+ while B2 485-.



Page & Key Explanation



After turning on central controller, home page will show as above and detailed menu is as following:

Menu/icon	Function
AC detailed menu 	Pop-up window will show after clicking the icon:  Online AC qty: indicating indoor unit quantity in good communication.  Offline AC qty: indicating indoor unit quantity in good communication previously and then in bad communication.  AC qty set in timer: indicating AC quantity set on the timer function.  Error AC qty: indicating AC quantity in malfunction.
Equipment Settings 	Press to enter equipment setting interface. Displays status of all connected indoor units. Each unit can be set to any available function individually or as a zone.

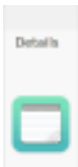
Page & Key Explanation

Menu/icon	Function
<p>Zone Settings</p> 	<p>Press to enter Zone Settings interface. Create zones from all connected units.</p>
<p>Details</p> 	<p>Press to enter details interface to view: AC condition/mode condition, error code, running time & parameters.</p>
<p>Schedule Settings</p> 	<p>Click to enter schedule settings interface, the following setting can be operated: After entering, it will display all schedule settings lists. One or multi days in a week can be chosen for timing setting. Timer on/off, temperature, mode, fan, temperature range(16-30°C), etc.</p>
<p>System Settings</p> 	<p>Click to enter the interface, and the following setting can be operated: Passwords, °C/°F, Time, Energy settings *Password= 12345</p>

Address Setting When Using Central Controller

When applying central controller, it is required to set address by dip switch for easy checking and maintenance.

When controlling MRV

System structure chart when controlling MRV:

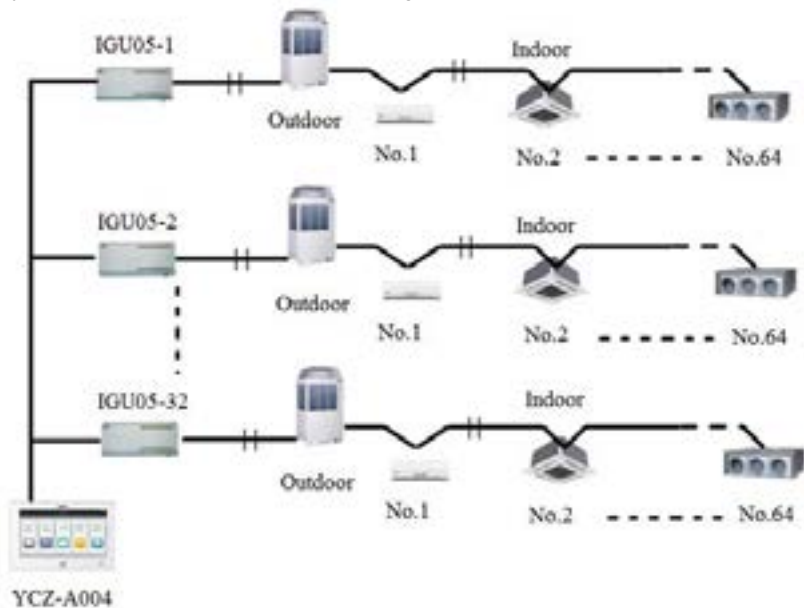

Address Setting When Using Central Controller

For every system of AC, address starts from No. 1 to last indoor unit of the system. If totally 20 indoor units are connected in one system, address should be 1-20; if 50 in one system, address should be 1-50; the biggest address is 64.

Note: every indoor address starts from 1.

1. Indoor address setting

The address used in central control or energy system								
SW03								Central address
(1)	(2)	(3)	(4)	(5)	(6)	(7)	(8)	
1	0	0	0	0	0	0	0	Central address=1
1	0	0	0	0	0	0	1	Central address=2
1	0	0	0	0	0	1	0	Central address=3
1	0	0	0	0	0	1	1	Central address=4
1	0	0	0	0	1	0	0	Central address=5
1	0	0	0	0	1	0	1	Central address=6
1	0	0	0	0	1	1	0	Central address=7
1	0	0	0	0	1	1	1	Central address=8
1	0	0	0	1	0	0	0	Central address=9
1*		SW03_1 must be set to 1 when connecting to this central controller.						

Address Setting When Using Central Controller

2. IGU05 Adapter Address Setting

1	2	3	4	5	6	7	8	Converter address
-	-	-	0	0	0	0	0	1
-	-	-	0	0	0	0	1	2
-	-	-	0	0	0	1	0	3
-	-	-	0	0	0	1	1	4
-	-	-	0	0	1	0	0	5
-	-	-	0	0	1	0	1	6
-	-	-	0	0	1	1	0	7
-	-	-	0	0	1	1	1	8
-	-	-	0	1	0	0	0	9
-	-	-	0	1	0	0	1	10
-	-	-	0	1	0	1	0	11
-	-	-	0	1	0	1	1	12
-	-	-	0	1	1	0	0	13
-	-	-	0	1	1	0	1	14
-	-	-	0	1	1	1	0	15
-	-	-	0	1	1	1	1	16
-	-	-	1	0	0	0	0	17
-	-	-	1	0	0	0	1	18
-	-	-	1	0	0	1	0	19
-	-	-	1	0	0	1	1	20
-	-	-	1	0	1	0	0	21
-	-	-	1	0	1	0	1	22
-	-	-	1	0	1	1	0	23
-	-	-	1	0	1	1	1	24
-	-	-	1	1	0	0	0	25
-	-	-	1	1	0	0	1	26
-	-	-	1	1	0	1	0	27
-	-	-	1	1	0	1	1	28
-	-	-	1	1	1	0	0	29
-	-	-	1	1	1	0	1	30
-	-	-	1	1	1	1	0	31
-	-	-	1	1	1	1	1	32

Function Operation

Equipment Settings



Picture 1

Press the “Equipment Settings” key on home page to enter the display interface as shown in picture 1.

 is the return button.

 means you can view air-conditioners as grouping established. Press “Zone” button to select zones to be displayed.

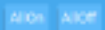
 is the All on/All off button. The All on/All off button is used to control the indoor units currently selected and displayed.

Function Operation



Picture 2

For example: Press the 3rd floor in picture2, it will show all indoor units on the 3rd floor, as shown in picture3.



Picture 3

Function Operation

Each grid represents an indoor unit in the air-conditioner display area, and each page can display 10 indoor units. Slide around the screen to turn pages on the screen. Indoor unit is shown as picture 4.

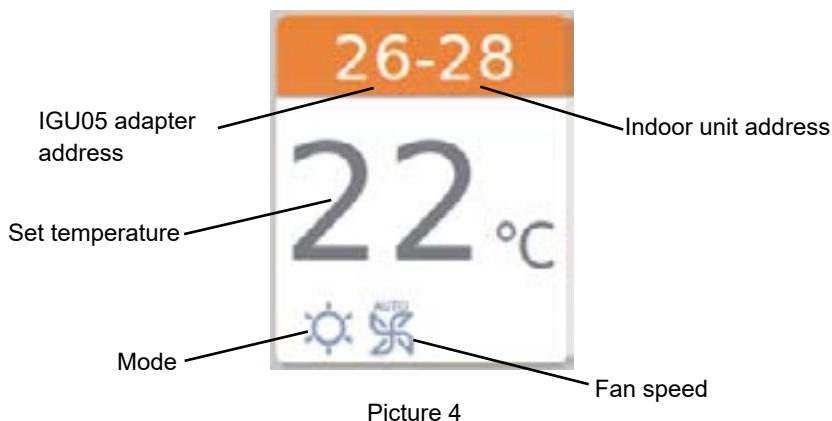

The colors in the background of the address represents the operation modes.
Heating Mode--orange
Cooling Mode--dark blue
Dehumidify mode--light blue

Function Operation

Press on the unit icon to enter the air-conditioner setting interface, as shown in picture5.

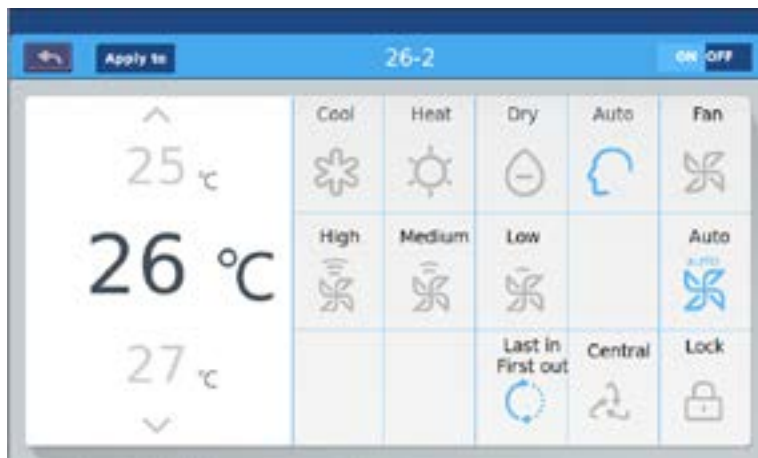

Picture 5

Setting interface:

Temperature setting: By sliding up/down or by pressing arrow \wedge / \vee icons in the temperature selection area, you can change the setting temperature.

Set Mode: Press the corresponding mode icon, the setting is successful if the icon is lighted up. Only one mode can be chosen.

Set Wind Speed: Press the corresponding wind speed icon, the setting is successful if the icon is lighted up. Only one wind speed can be chosen.

Set control mode: Last in first out/Central control/Locked. If the current system does not support this setting, the button will be hidden.













Last in first out: Most recent selection will be used whether from the central controller or local wired/wireless controller.

Central: Central controller has full control. Local wired/wireless controller can only power on/off unit.

Lock: Central controller has full control. Local wired/wireless controllers have no control and will only display current settings.

Function Operation

Icon Instruction:

 Cooling Mode	 Last in first out
 Heating Mode	 Central Control
 Dry Mode	 Locked
 Intelligent Mode	 Low Speed
 Wind Mode	 Automatically
 High Speed	 Medium Speed

Function Operation

Batch change the indoor unit mode setting: After setting one unit, tap

Apply to

and window will pop out as shown in picture 6.

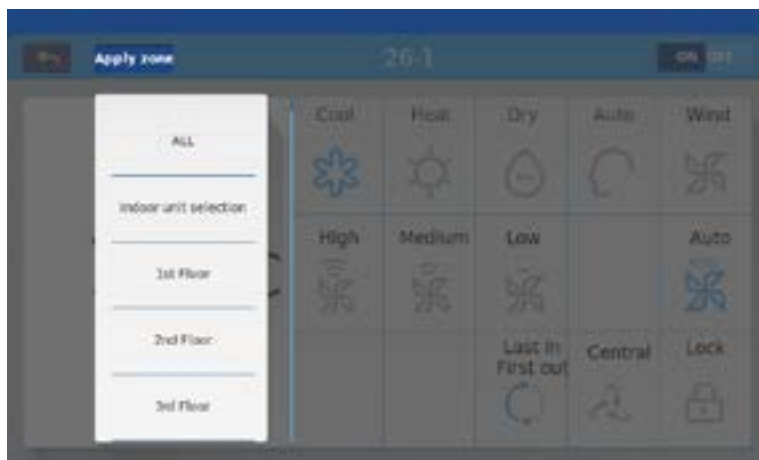

Picture 6

If you choose “All”, then all indoor units will operate as ordered.

If you choose “indoor unit selection”, then the page will turn to interface displaying all indoor units, press the indoor unit icons to choose the indoor units (the chosen ones will turn to dark color), they will operate as ordered. As shown in picture 6, “1st Floor ” “2nd Floor” “3rd Floor” are zoned areas, choose one area and all indoor units in that zone will operate as ordered.

Renaming Indoor Units

To change the name of an indoor unit: as shown in picture 7, press the air-conditioner number 26-1, then it will display the textbox “please input device name”. Tap the blank text box to pop out the keyboard. After typing in the name, press “ENTER” . The name length is limited to 12 characters.

Function Operation



Picture 7

Such as changing the name to “26-1 Office3”. After changing, it will be displayed in center. When you return to the previous screen, the corresponding unit icon name will also be changed.

Zone Settings



Picture 1

Function Operation

Tap zone settings on the homepage to enter the zone setting interface, as shown in picture1.

It will display a list of all current zone groups in the left column. Selecting a zone will display all connected air-conditioners grouped to that zone in the main display area.

Adding new group: press  to pop out the window as shown in picture 2.

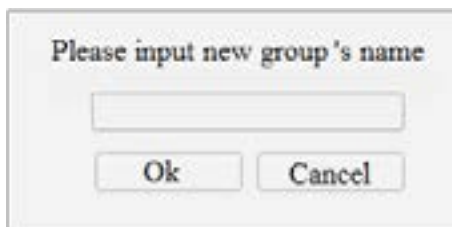

Picture 2

Tap the blank text box, enter the group name (12 characters max) and press the "ENTER" button on the keyboard. Press OK key in the pop window to enter the interface shown in picture3.

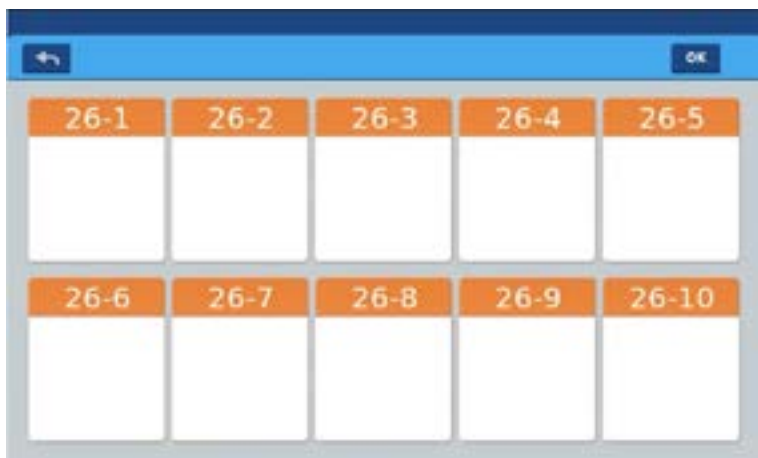

Picture 3

Function Operation

The interface displays all connected indoor units. Tap to choose desired units to add to group. The selected unit will turn to blue after being tapped (tap again to deselect).

For example: after tapping indoor units 26-1, 26-2, it will display as shown in picture 4.

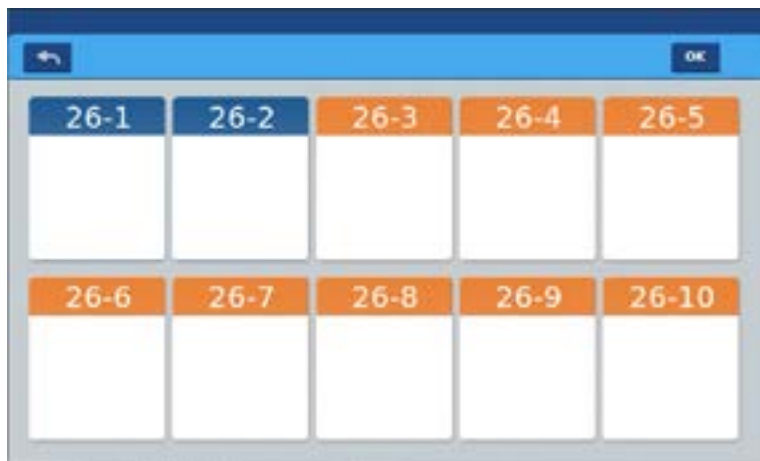

Picture 4

After choosing the indoor units, press OK key at the top-right corner. The new zone will be displayed on the left.

Tap the group name on the left, the background will be highlighted, the two indoor units of the 1st floor zone will be shown. See picture5.

Each zone supports up to 64 devices.

Press  to return to the last layer when grouping indoor units.

Function Operation



Picture 5

In picture5, choose one group and then tap the **Edit** button. It will pop out a window with three options, as shown in picture6:



Picture 6

Edit group name: Changes the group's name.

Edit group's dev: Add/remove indoor units grouped in a zone.

Remove this group: Deletes a zone group. Confirm "to remove this group?"

Tap "OK" to delete the group. All indoor units in that group will become ungrouped.

Tap "cancel" to come back to picture 5.

Function Operation

Details

Press details button on homepage to view detailed unit information, as shown in picture1.

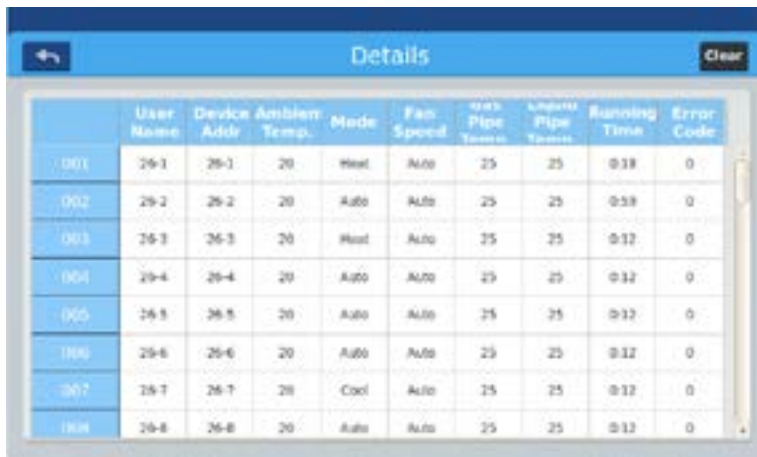

The screenshot shows a mobile application interface titled "Details". At the top left is a back arrow icon, and at the top right is a "Clear" button. Below the title is a table with 10 columns and 8 rows of data. The columns are: Unit No., User Name, Device Addr, Ambient Temp., Mode, Fan Speed, Gas Pipe Temp., Liquid Pipe Temp., Running Time, and Error Code. The rows represent units 001 through 008. Units 001-006 are in "Heat" mode, unit 007 is in "Cool" mode, and unit 008 is in "Auto" mode. All units show a fan speed of "Auto", gas pipe temperature of 25, liquid pipe temperature of 25, and an error code of 0. Running times range from 0:11 to 0:18.

Unit No.	User Name	Device Addr	Ambient Temp.	Mode	Fan Speed	Gas Pipe Temp.	Liquid Pipe Temp.	Running Time	Error Code
001	26-1	26-1	26	Heat	Auto	25	25	0:18	0
002	26-2	26-2	26	Auto	Auto	25	25	0:18	0
003	26-3	26-3	26	Heat	Auto	25	25	0:12	0
004	26-4	26-4	26	Auto	Auto	25	25	0:12	0
005	26-5	26-5	26	Auto	Auto	25	25	0:12	0
006	26-6	26-6	26	Auto	Auto	25	25	0:12	0
007	26-7	26-7	26	Cool	Auto	25	25	0:12	0
008	26-8	26-8	26	Auto	Auto	25	25	0:12	0

Picture 1

Vertical axis displays the name of the air-conditioner according to the order of the unit numbers, horizontal axis displays user name, air-conditioner number, setting temperature, setting mode, setting wind speed, gas pipe temperature, liquid pipe temperature, operating time and faults information.

Clicking **Clear** to pop out password input window. Inputting password and click "Ok", all current data (except running time) will be cleared. If clicking "Cancel", it will return to previous page.

Function Operation

Schedule Settings

Choose the Schedule Settings on the homepage to enter the initial schedule setting interface as shown in picture 1.

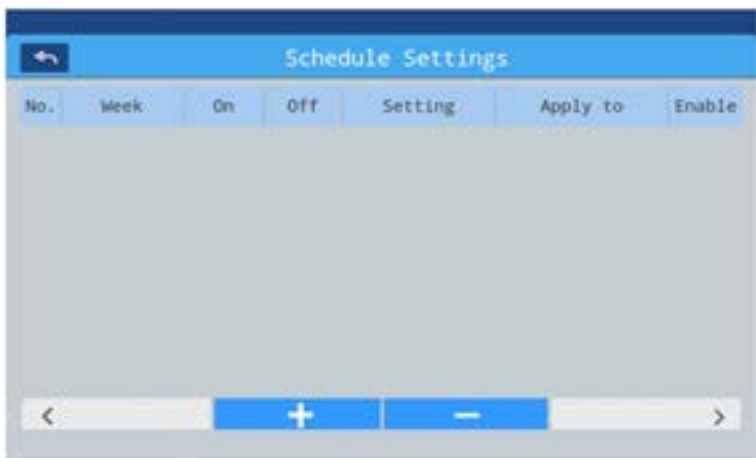

Picture 1

Press **+** to add new schedule settings, as shown in picture 2. "On" shows when the machine starts up and "Off" shows when the machine shuts down.

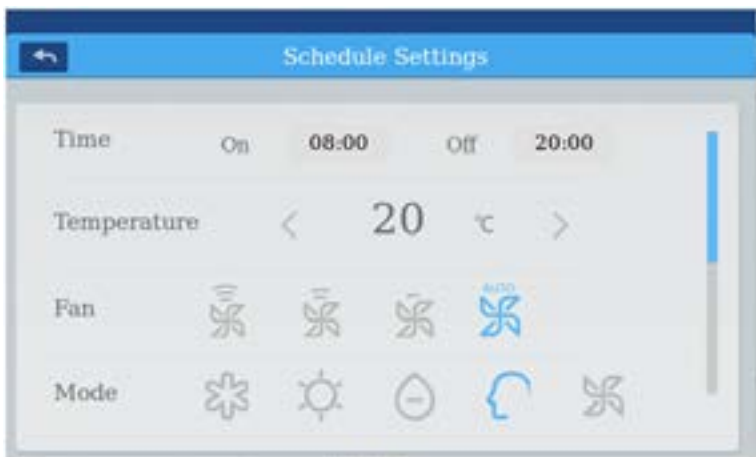

Picture 2

Function Operation

Click the time text (such as 08:00 in picture 2) to pop out the window

Time set	
11	17
12	18
01	19

choose the time of startup. Then set the temperature, fan speed and mode. Slide down and set the area applied to and weekly in the interface as shown in picture3.

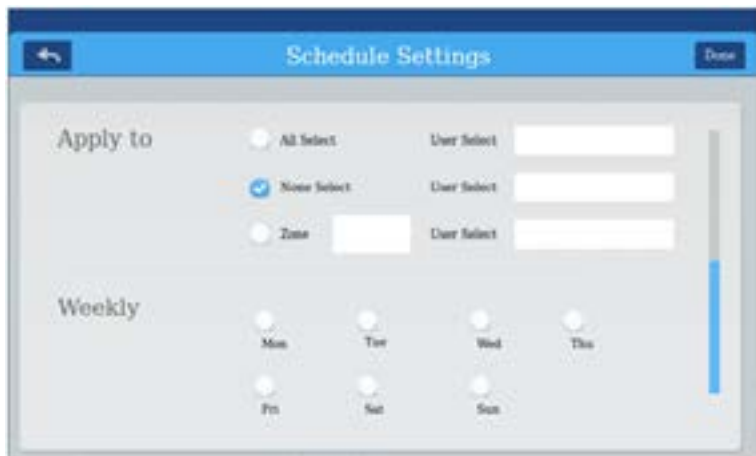

Picture 3

Click "Done" key after setting.

Apply Zone Settings:

- All select: Will initially attach the schedule settings to all connected units. A pop window appears and units can be deselected if desired.
- None select: This won't initially attach the schedule settings any unit. A pop window will appear and units will need to be selected.
- Zone: A pop window will appear and provide an option to select which zones to apply the schedule settings to.

Function Operation

Scheduled Items:

The schedule will be displayed as shown in picture 4 after settings are complete. The table shows the detailed information of this schedule. Click the corresponding item to change the time, fan speed, mode, and other items as shown in pic picture 2.

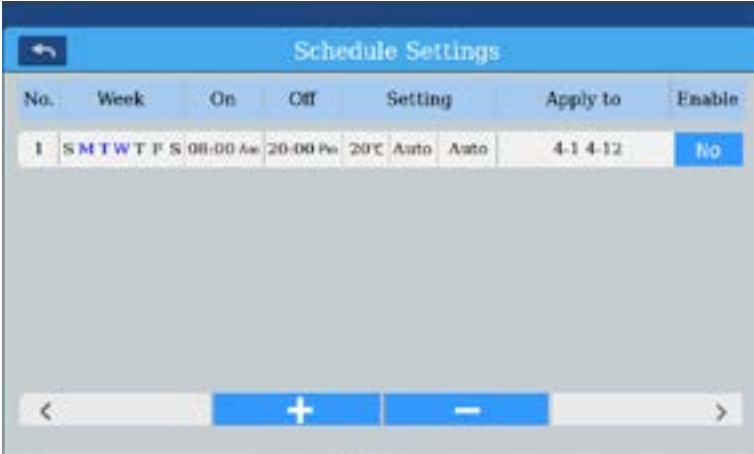

The screenshot shows a mobile application interface titled "Schedule Settings". At the top left is a back arrow icon. Below the title is a table with the following columns: No., Week, On, Off, Setting, Apply to, and Enable. The first row contains the following data: No. 1, Week S M T W T F S, On 08:00 AM, Off 20:00 PM, Setting 20°C Auto Auto, Apply to 4-1 4-12, and a blue "NO" button in the Enable column. At the bottom of the screen are navigation buttons: a left arrow, a blue "+" button, a blue "-" button, and a right arrow.

No.	Week	On	Off	Setting	Apply to	Enable
1	S M T W T F S	08:00 AM	20:00 PM	20°C Auto Auto	4-1 4-12	NO

Picture 4

“Enable”: Yes will run the schedule. No will idle it.

“Apply to”: Click the table can check which indoor units are operating on this schedule.

Tap “-” to select and delete a schedule.

Tap “+” to add another schedule.

Function Operation

System Settings:

To access System Settings a password must be entered. Password is 12345.



Picture 1

Click OK key enter system settings page after inputting password. System setting page includes 4 contents, as picture 2.

Extra

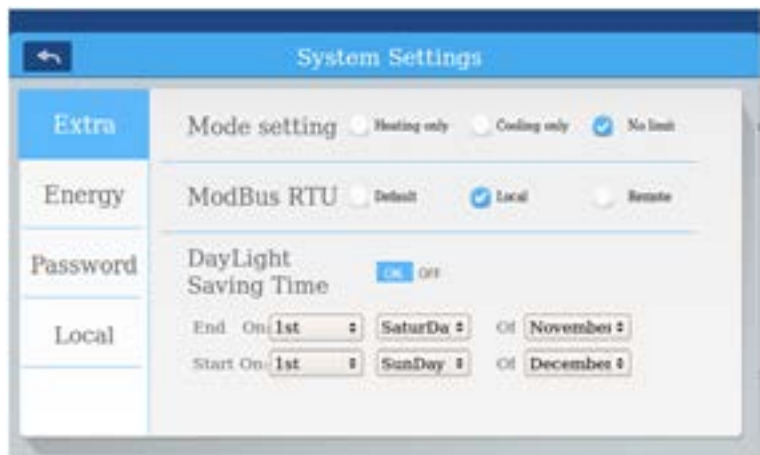

Function Operation

Mode setting: Tap to choose model setting. It will show if selected. Default is no limit.

Daylight Saving Time: You can set saving function through the button

ON OFF.

You can select the application range from the bottom menu.

Energy

As picture 3

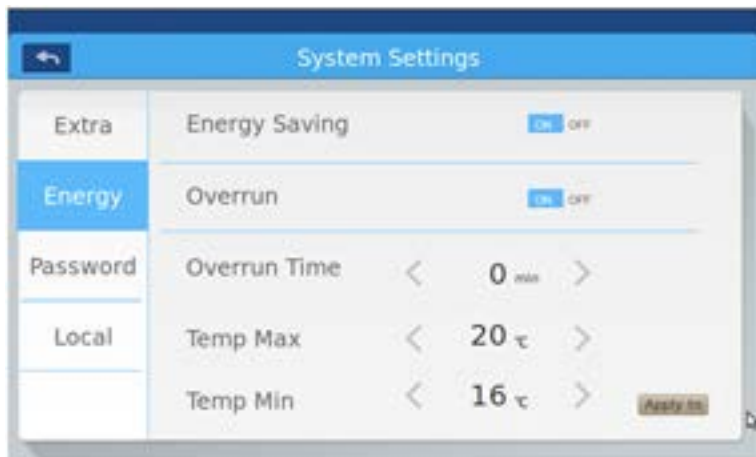

Picture 3

Energy Saving: Default is "ON".

Overrun: Default is "ON". Must be set to on to set limits.

Overrun time: Tap and to set the overrun time duration.

Temp Max & Temp Min: Limits can be placed to prevent users from adjusting the temperatures too high or too low. Use the and to adjust the limits.

After setting, tap , a pop window with zones will display. Select "apply to all zone" or "apply to one zone". The upper limit and lower limit temperatures only take effect when applied to a zone. The system maximum temperature limit is 30°C (86°F). The minimum temperature limit is 16°C (60°F).

Function Operation

Password

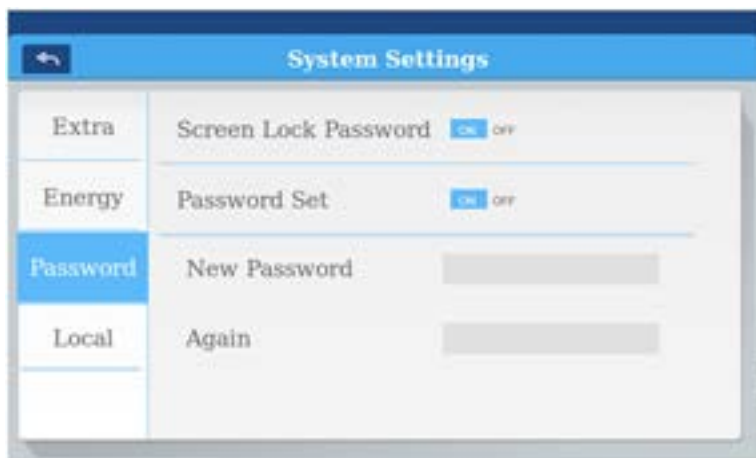

Picture 4

Screen lock password: Press ON OFF to turn ON/OFF the screen lock password.

Password setting: You can choose ON OFF to decide if password is necessary.

Input/confirm new password: Input the password (length 4-10) twice. It will remind "update password ok", the new password will come into effect when you leave this page. Otherwise it will remind "update password fail".

Note: default password is 12345.

Function Operation

Local setting

Local configurations are made here.

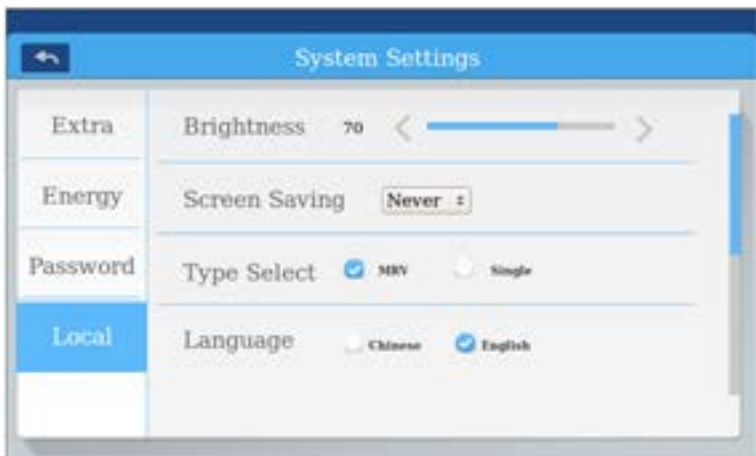

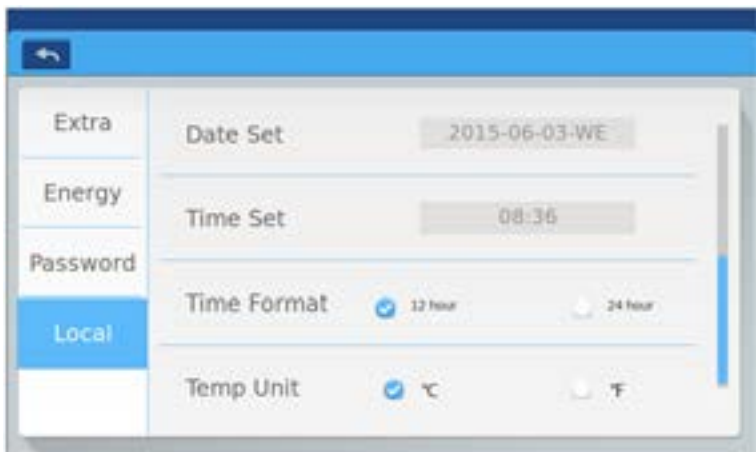

Picture 5





Picture 6

Function Operation

Brightness setting: You can turn up or down through the button  and  .
Screen saving: screen saving time can be set: never, 15s, 30s, 1min, 5min, 10min.

Type selection: Choose your unit model. It will show  after you tap on the unit type.

Language selection: Choose language. It will show  after you tap on the language.

Date and day setting: It will show a date pop window after you click the date box; you can choose the date and day through  .

Time setting: It will show a time pop window after you click the timebox, you can choose the time through  .

Time format: It will show  after you tap on the time format.

Temperature unit: It will show  after you tap on the temp. unit.

Note:

When there is a change on device name, zone settings, schedule settings, system settings, press "Save" on the top right corner of the home page. The control will save the settings and reset.

Installation

Installation dimension

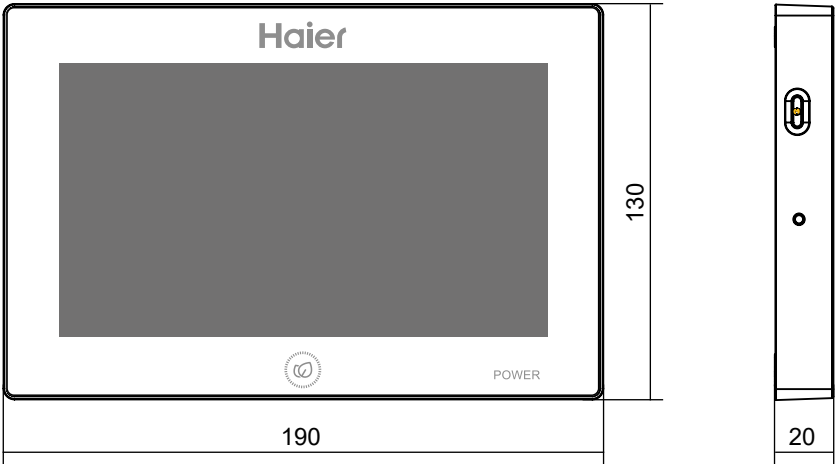

Wiring diagram

Wiring diagram between central controller and converter board (IGU05).

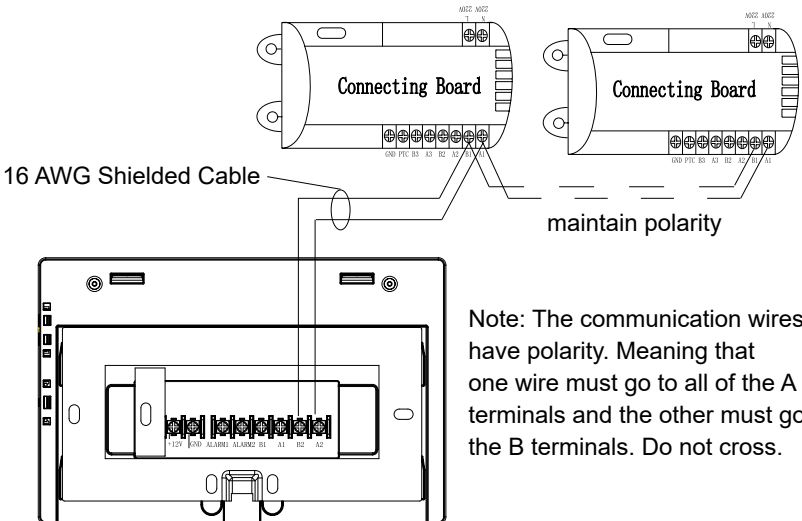

Installation

Installation condition

Electronic controls may receive interference from other electrical devices. This control may not operate as desired around computers, auto-doors, elevators, or other equipment what can produce noise.

Keep away from moisture and from excessive vibration.

Don't install in the place direct sunlight or near a heat source.

Installation Directions

Mount the bracket to the wall using at least 2 of the holes marked ABC.

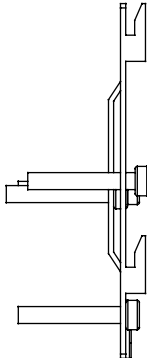
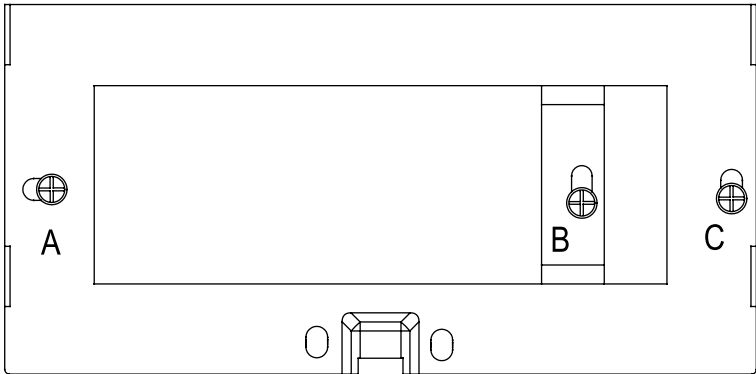

Orientate the bracket so that the open ends of the hooks are facing up.

Installation

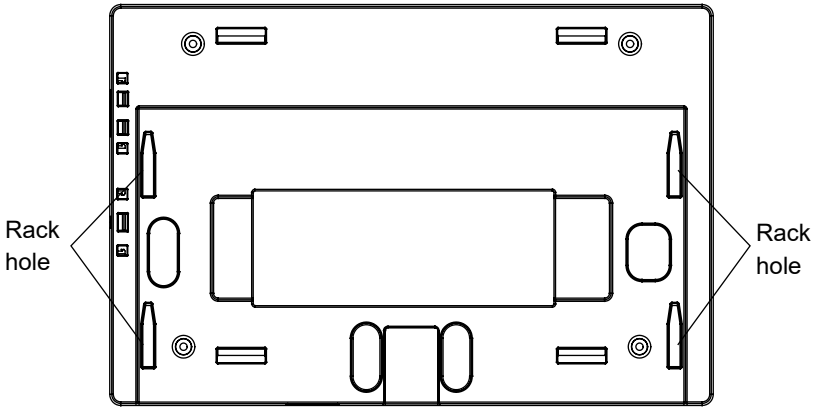

The installation of power adapter

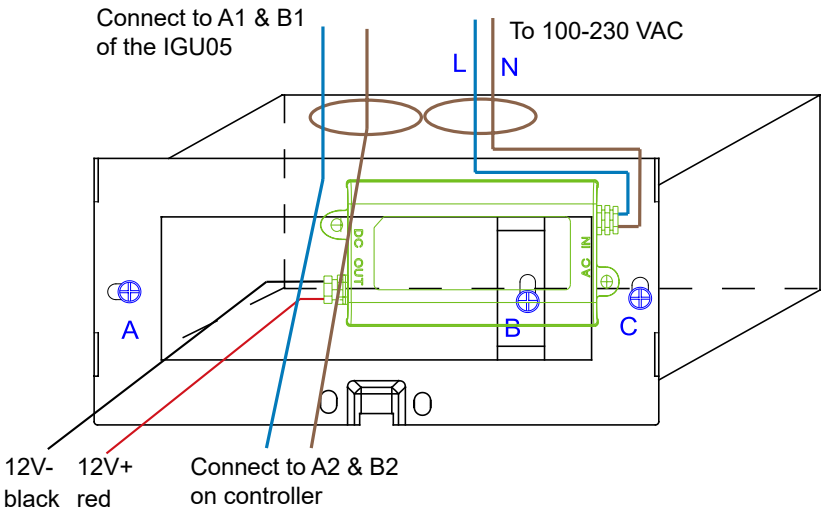

The power transformer that ships with the control can be connected to any AC voltage between 100-230. The red (+) and black (-) is to be connected to the +&- terminals of the control. The control wires connect to A2 & B2.

Installation

Wiring between power adapter and central controller

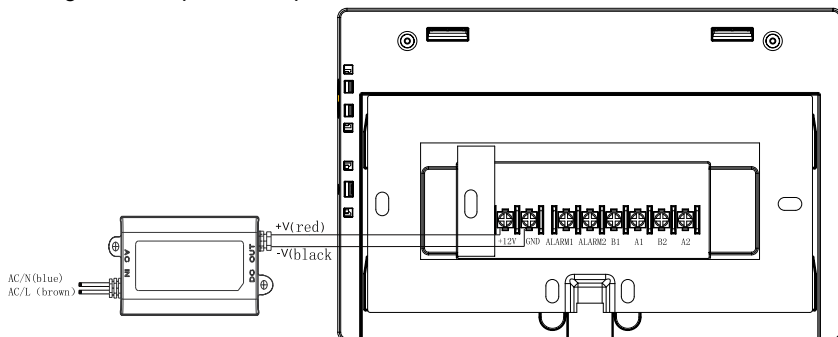

After connecting wires, put the central controller on the bracket

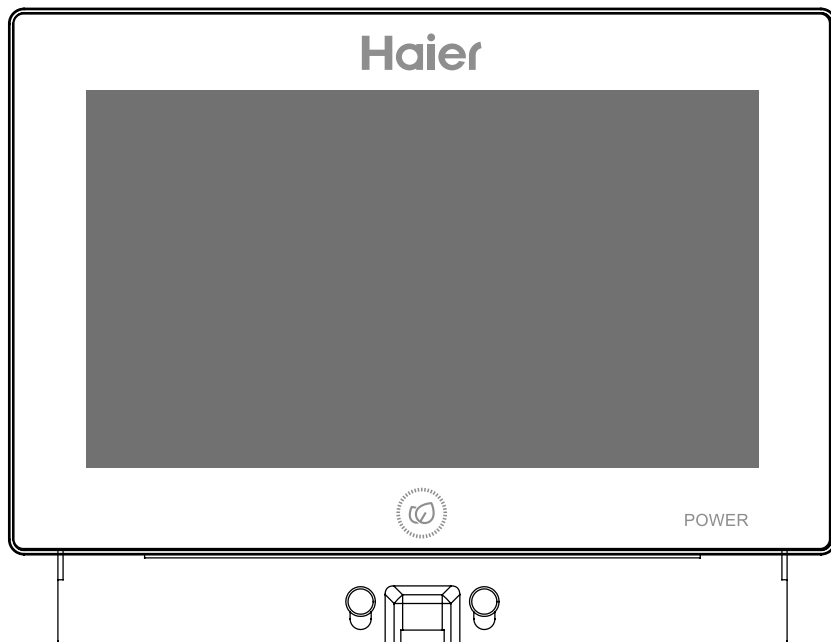

Qingdao Haier Air Conditioner Electric Co.,Ltd.

Haier Industrial Park,Qianwangang Road,Eco-Tech Development Zone,
Qingdao 266555,Shandong,P.R.C.